

A-A(2:1)

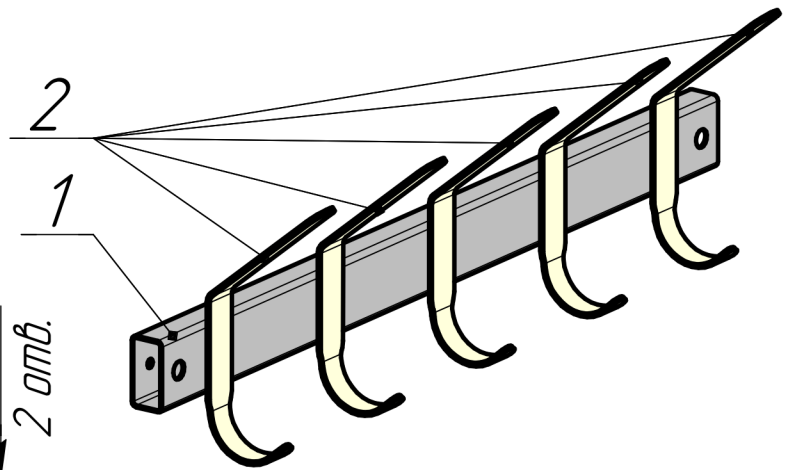
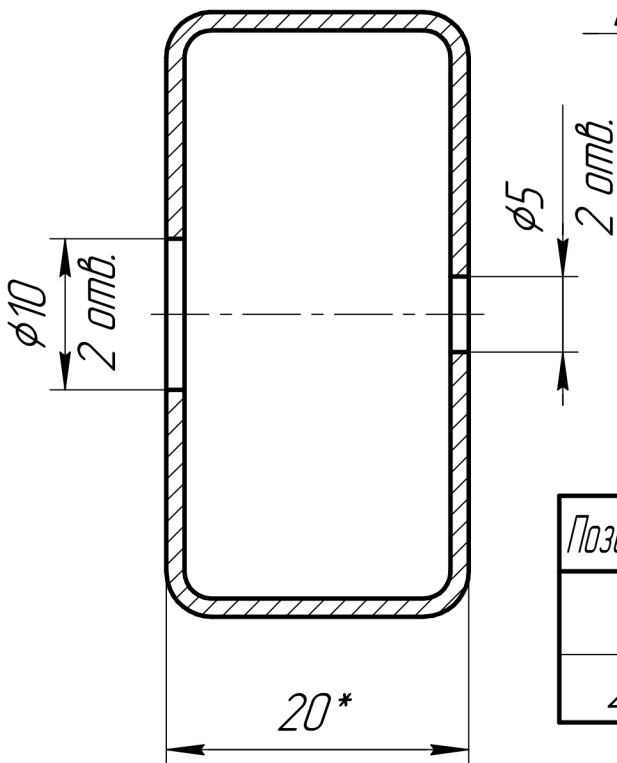

Позиция	Деталь	Масса, кг	Кол-во
1	Труба 40x20x1,2 L=500	0,520	1
2	Крючок (штамповка)	0,064	5